RT6252BHGJ6F, 17V_{IN}, 2A, ACOT[®] Buck Converter Evaluation Board

General Description

The Evaluation Board demonstrates the RT6252BHGJ6F to be designed for a 5V/2A output from a 4.5V to 17V input at 580kHz switching frequency. The device possesses an accurate reference voltage and integrates low R_{DS(ON)} power MOSFETs to achieve high efficiency. The RT6252B operates in Forced PWM that helps meet tight voltage regulation accuracy requirements. The RT6252B senses both FETs current for a robust overcurrent protection (OCP). The device features cycle-by-cycle current limit protection to prevent the device from the catastrophic damage in output short circuit, overcurrent or inductor saturation conditions. The device also includes input undervoltage lockout, output undervoltage protection, and over-temperature protection (OTP) to provide safe and smooth operation in all operating conditions.

Table of Contents

General Description	1
Performance Sepcification Summary	2
Power-up Procedure	2
Detailed Description of Hardware	3
Bill of Materials.....	4
Typical Applications	5
Evaluation Board Layout.....	8
More Information.....	10
Important Notice for Richtek Evaluation Board.....	10

Performance Specification Summary

Summary of the RT6252BHGGJ6F Evaluation Board performance specification is provided in Table 1. The ambient temperature is 25°C.

Table 1. RT6252BHGGJ6F Evaluation Board Performance Specification Summary

Specification	Test Conditions	Min	Typ	Max	Unit
Input Voltage Range		4.5	--	17	V
Output Current		0	--	2	A
Default Output Voltage		--	5	--	V
Operation Frequency		--	580	--	kHz
Output Ripple Voltage	I _{OUT} = 2A	--	25	--	mVp-p
Line Regulation	I _{OUT} = 2A, V _{IN} = 4.5V to 17V	--	±1	--	%
Load Regulation	V _{IN} = 12V, I _{OUT} = 0A to 2A	--	±1	--	%
Load Transient Response	I _{OUT} = 1A to 2A	--	±2	--	%
Maximum Efficiency	V _{IN} = 12V, V _{OUT} = 5V, I _{OUT} = 2A	--	91	--	%

Power-up Procedure

Suggestion Required Equipments

- RT6252BHGGJ6F Evaluation Board
- DC power supply capable of at least 17V and 2A
- Electronic load capable of 6A
- Function Generator
- Oscilloscope

Quick Start Procedures

The Evaluation Board is fully assembled and tested. Follow the steps below to verify board operation. Do not turn on supplies until all connections are made. When measuring the output voltage ripple, care must be taken to avoid a long ground lead on the oscilloscope probe. Measure the output voltage ripple by touching the probe tip and ground ring directly across the last output capacitor.

Proper measurement equipment setup and follow the procedure below.

- 1) With power off, connect the input power supply to VIN and GND pins.
- 2) With power off, connect the electronic load between the VOUT and nearest GND pins.
- 3) Turn on the power supply at the input. Make sure that the input voltage does not exceeds 17V on the Evaluation Board.
- 4) Check for the proper output voltage using a voltmeter.
- 5) Once the proper output voltage is established, adjust the load within the operating ranges and observe the output voltage regulation, ripple voltage, efficiency and other performance.

Detailed Description of Hardware

Headers Description and Placement

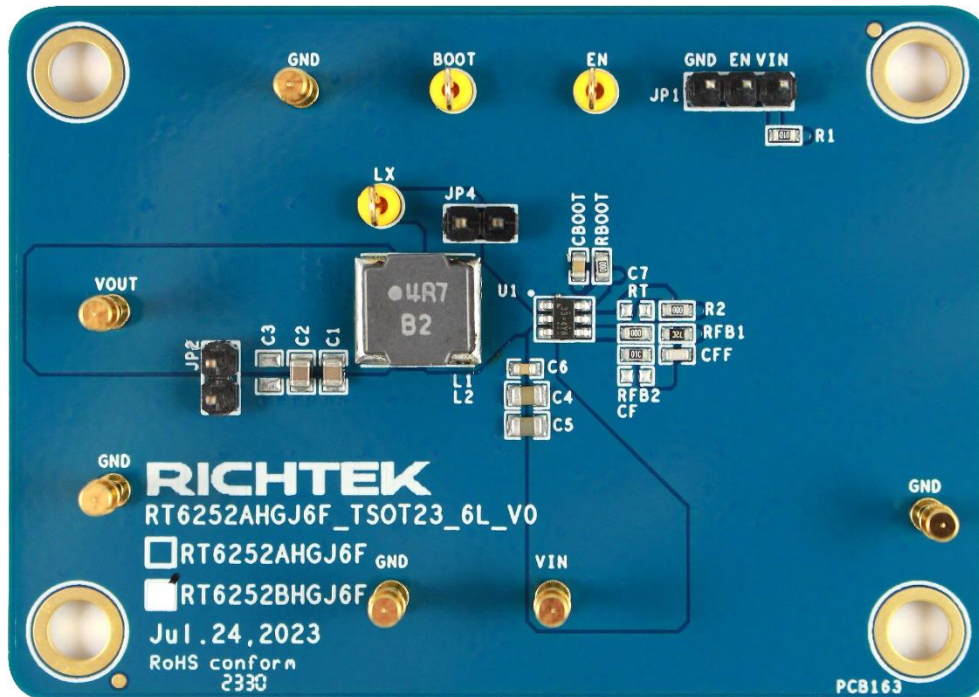

Carefully inspect all the components used in the EVB according to the following Bill of Materials table, and then make sure all the components are undamaged and correctly installed. If there is any missing or damaged component, which may occur during transportation, please contact our distributors or e-mail us at evb_service@richtek.com.

Test Points

The EVB is provided with the test points and pin names listed in the table below.

Test Point/ Pin Name	Function
VIN	Input voltage.
VOUT	Output voltage.
GND	Ground.
EN	Enable test point.
JP1	EN jumper. Connect EN to VIN to enable, open to disable.
SW	Switch node test point.

Bill of Materials

VIN = 12V, VOUT = 5.0V, IOUT = 2A, fsw = 650kHz						
Reference	Count	Part Number	Value	Description	Package	Manufacturer
U1	1	RT6252BHJ6F	RT6252BHJ6F	Step-Down Converter	TSOT 23-6	RICHTEK
C1,C2	2	GRM219R60J226ME47D	22μF	Capacitor, Ceramic, 6.3V, X5R	0805	MURATA
C4, C5	2	GRM21BR61E106KA73L	10μF	Capacitor, Ceramic, 25V, X5R	0805	MURATA
C6, CBOOT	2	0603B104K500CT	0.1μF	Capacitor, Ceramic, 50V, X7R	0603	WALSIN
CFF	1	0603N220J500LT	47pF	Capacitor, Ceramic, 50V, NPO	0603	WALSIN
R1	1	WR06X1003FTL	100k	Resistor, Chip, 1/10W, 1%	0603	WALSIN
R2, RBOOT, RT	3	WR06X000 PTL	0k	Resistor, Chip, 1/10W, 1%	0603	WALSIN
RFB1	1	WR06X5492FTL	54.9k	Resistor, Chip, 1/10W, 1%	0603	WALSIN
RFB2	1	WR06X1002FTL	10k	Resistor, Chip, 1/10W, 1%	0603	WALSIN
L1	1	LSXNH8080YBL4R7NJG	4.7μH	Inductor	L-8x8	TAIYO YUDEN

Typical Applications

EVB Schematic Diagram

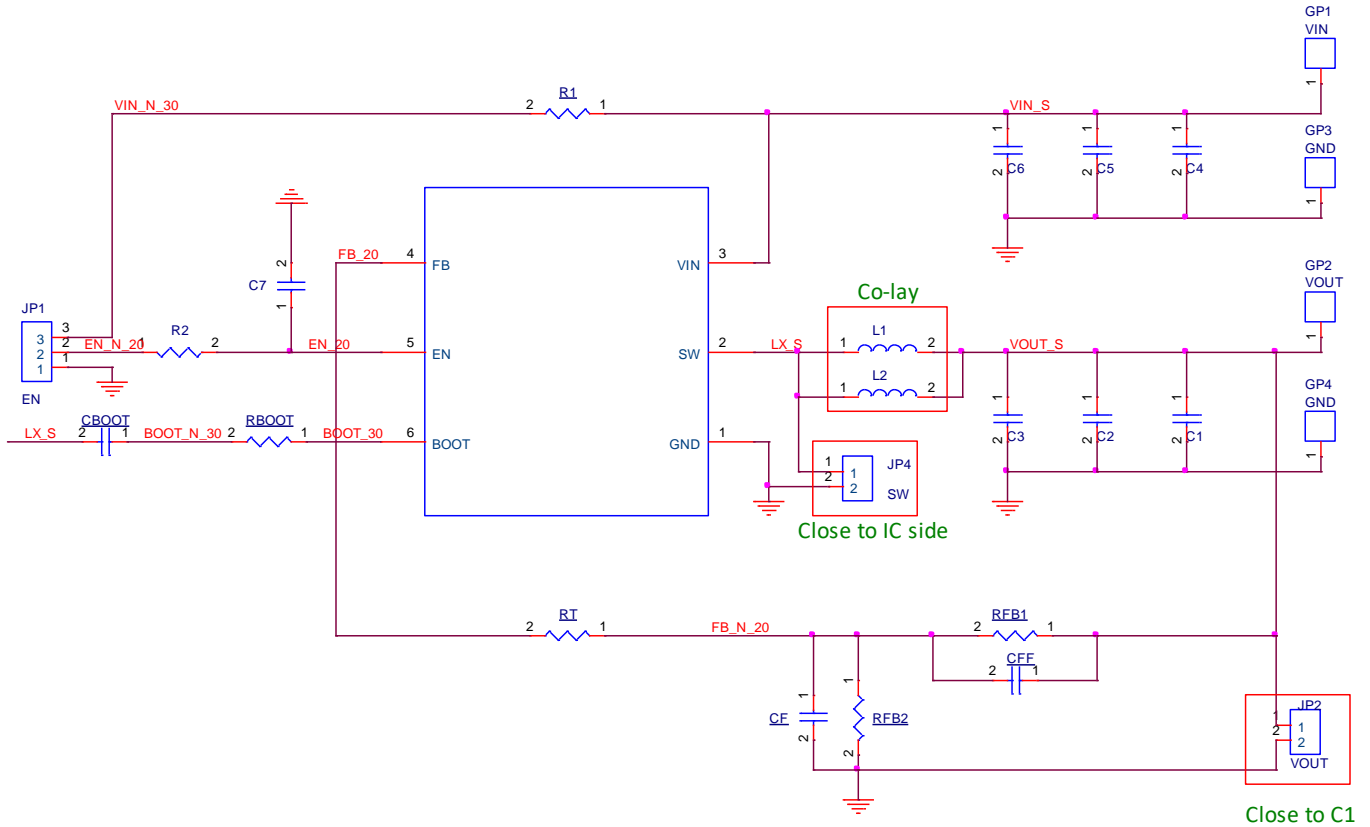

1. The capacitance values of the input and output capacitors will influence the input and output voltage ripple.
2. MLCC capacitors have degrading capacitance at DC bias voltage, and especially smaller size MLCC capacitors will have much lower capacitance.

Measure Result

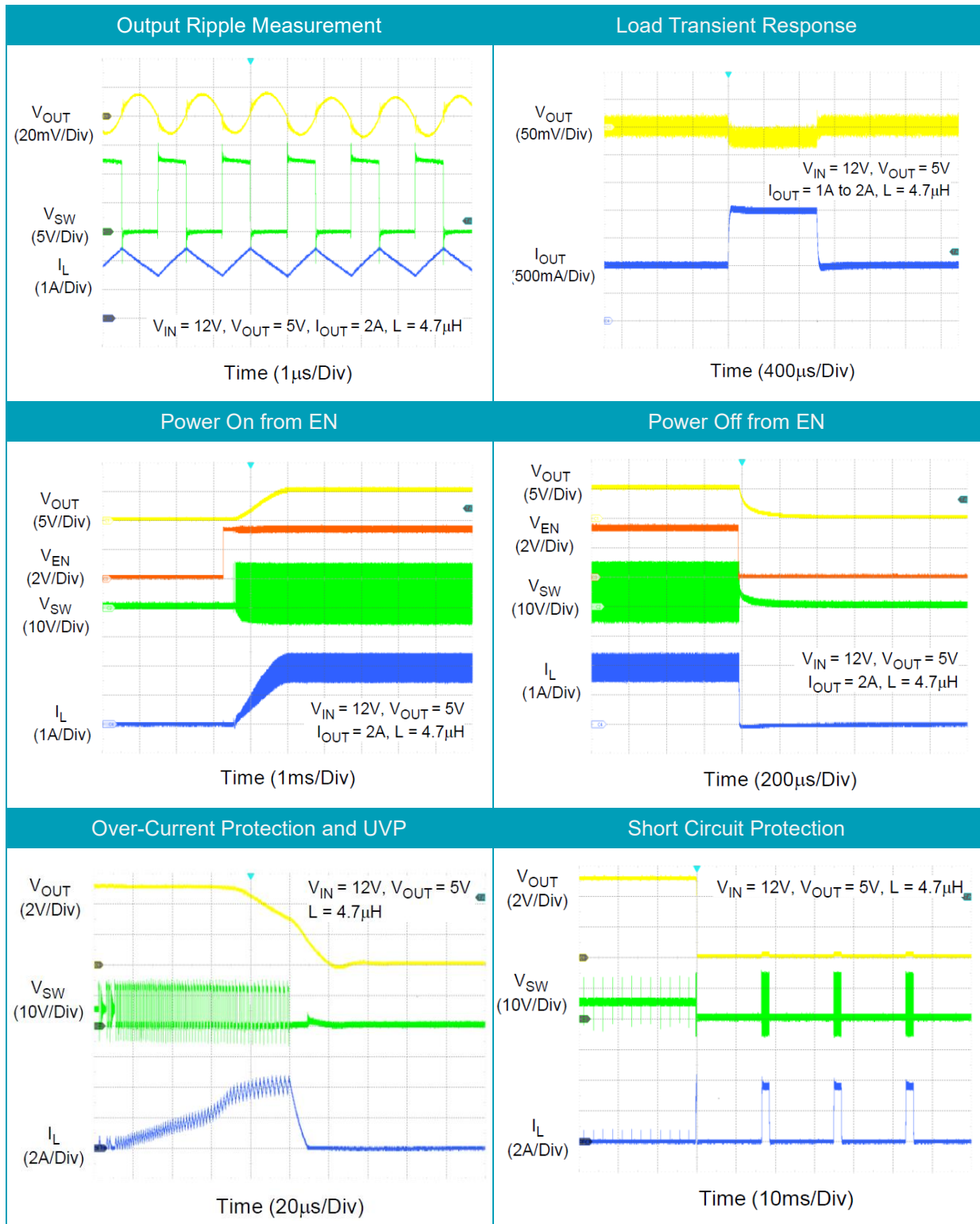

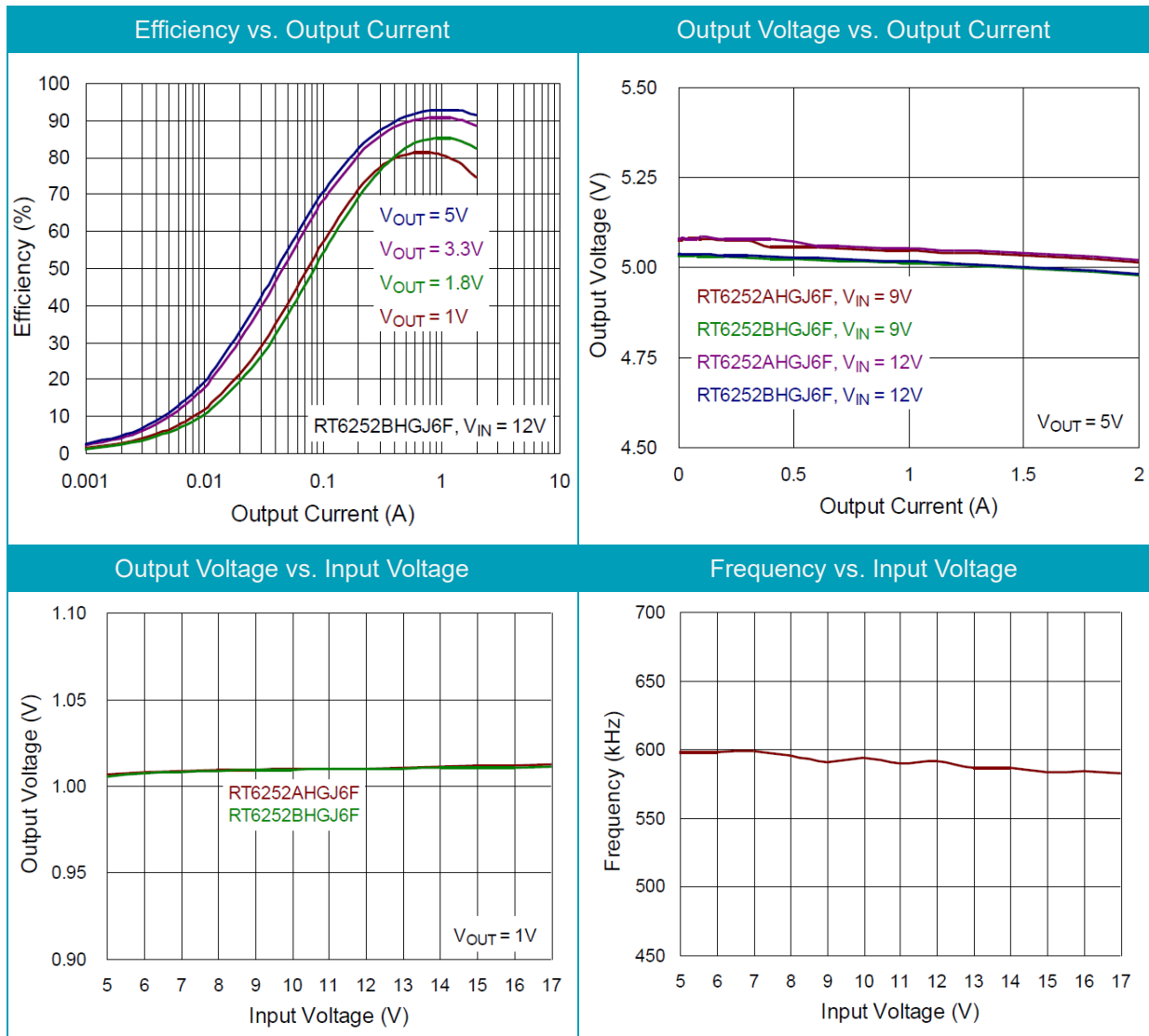

Note: When measuring the input or output voltage ripple, care must be taken to avoid a long ground lead on the oscilloscope probe. Measure the output voltage ripple by touching the probe tip directly across the output capacitor.

Evaluation Board Layout

Figure 1 to Figure 4 are RT6252BHJ6F Evaluation Board layout. This board size is 70mm x 50mm and is constructed on four-layer PCB, all layers with 1 oz. Cu.

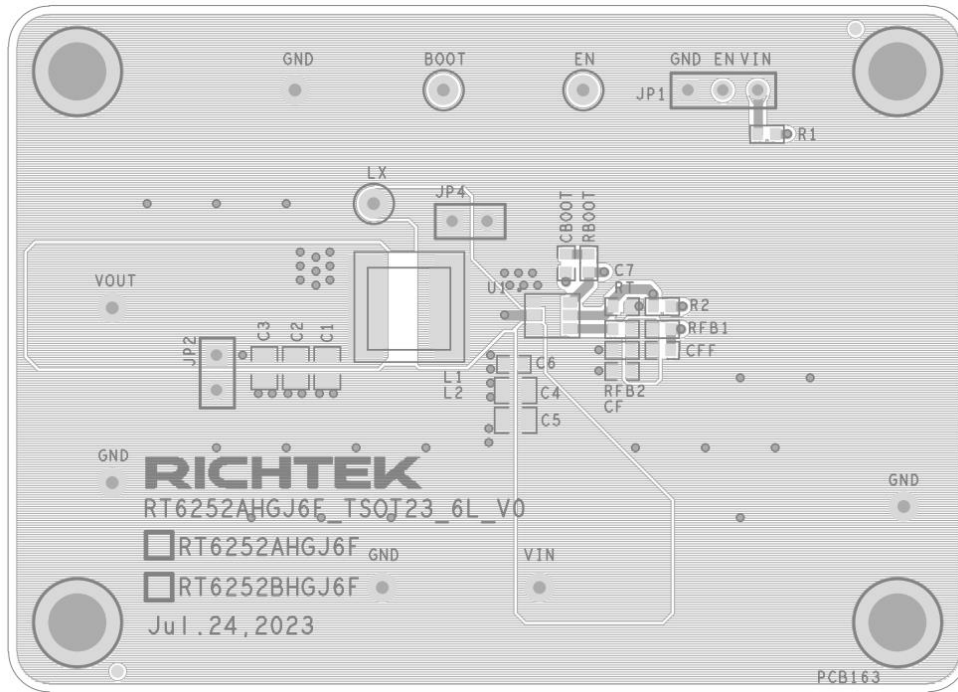

Figure 1. Top View (1st layer)

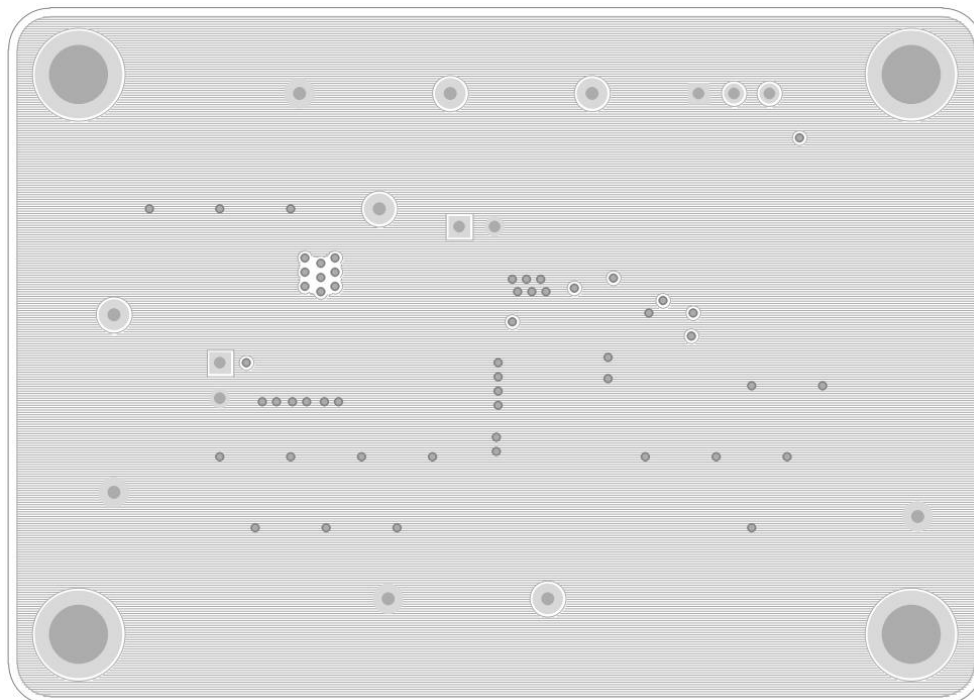

Figure 2. PCB Layout—Inner Side (2nd Layer)

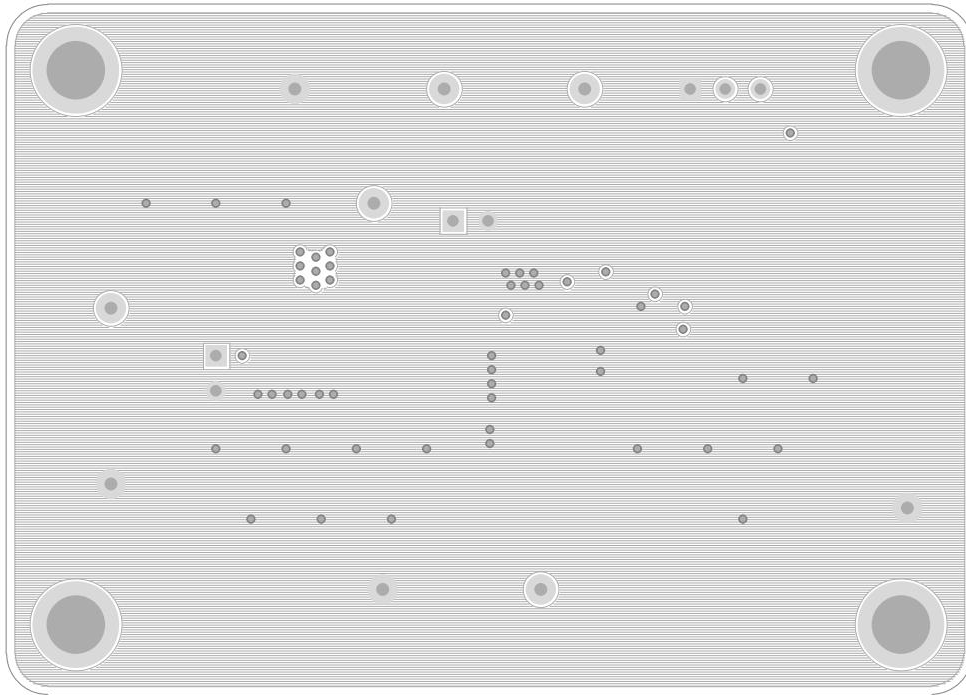

Figure 3. PCB Layout—Inner Side (3rd Layer)

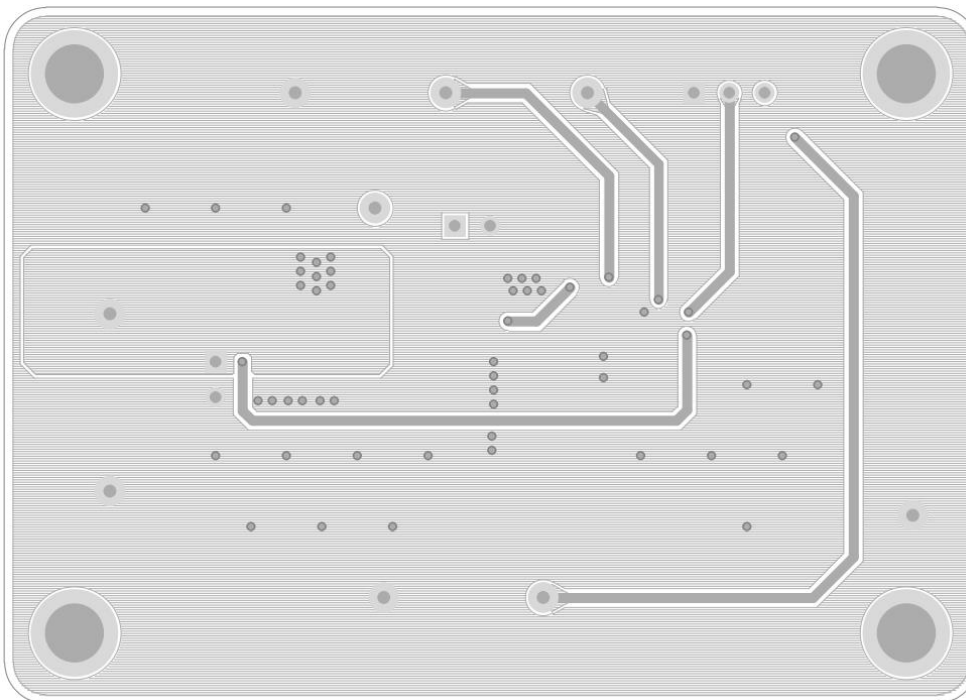

Figure 4. Bottom View (4th Layer)

More Information

For more information, please find the related datasheet or application notes from Richtek website

<http://www.richtek.com>.

Important Notice for Richtek Evaluation Board

THIS DOCUMENT IS FOR REFERENCE ONLY, NOTHING CONTAINED IN THIS DOCUMENT SHALL BE CONSTRUED AS RICHTEK'S WARRANTY, EXPRESS OR IMPLIED, UNDER CONTRACT, TORT OR STATUTORY, WITH RESPECT TO THE PRESENTATION HEREIN. IN NO EVENT SHALL RICHTEK BE LIABLE TO BUYER OR USER FOR ANY AND ALL DAMAGES INCLUDING WITHOUT LIMITATION TO DIRECT, INDIRECT, SPECIAL, PUNITIVE OR CONSEQUENTIAL DAMAGES.